

12.7mm, 14mm, 16mm

Divisible Duct Seal

Installation Instructions

Package Contents

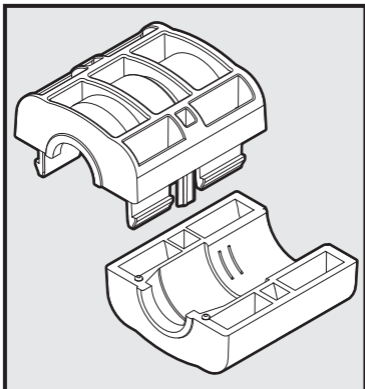

1.5mm-2.5mm*



2.5mm-3.5mm*



3.5mm-5.0mm*



5.0mm-6.5mm*

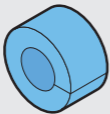

6.5mm-8.0mm*

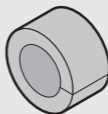

8.0mm-10.0mm*

*Cable Outer Dimensions



An Orbia Connectivity Solutions business.

Installation Instructions

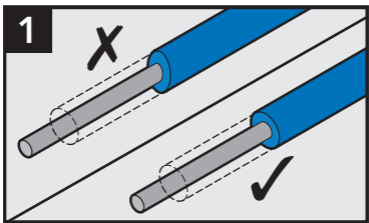

Cut duct straight.

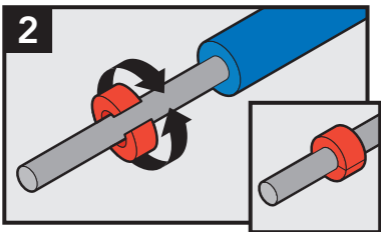

Select required seal and install on cable.

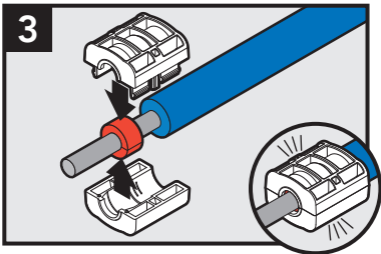

Install cover until it clicks.

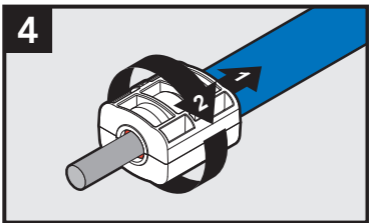

Turn connector while pushing towards the duct.